

Trimod^o Besta

Alarm, measurement and control with Trimod Besta



Switch-, flange- and float modules are selected acc. to the process parameters and the desired functions. This offers problem specific solutions using standard components and optimises the price/performance ratio.

Limiting maximum/minimum

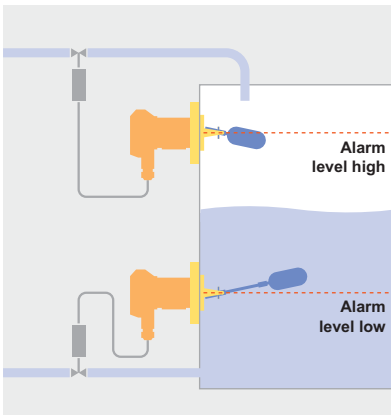

Pneumatic closed loop control

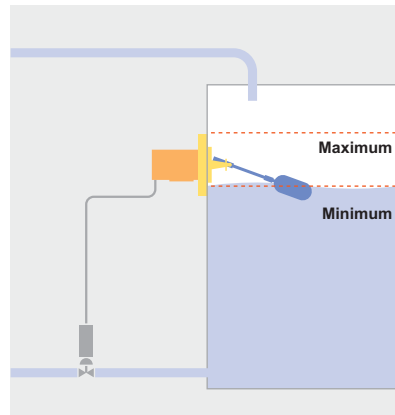

Open loop control for valves pumps and valves

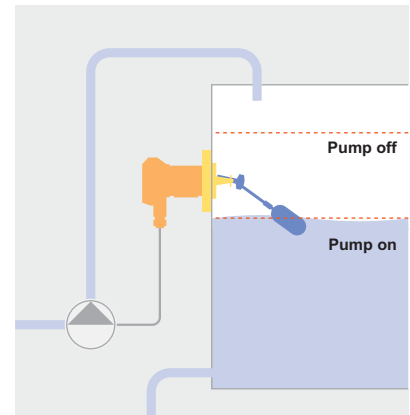

Open loop control for pumps and valves

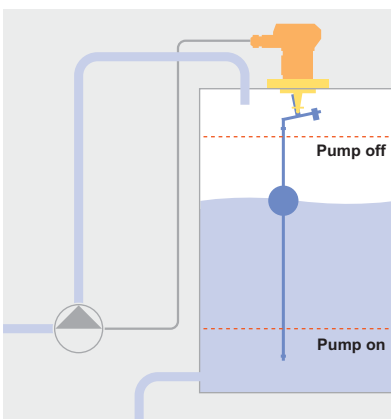

Limitation of separation layers

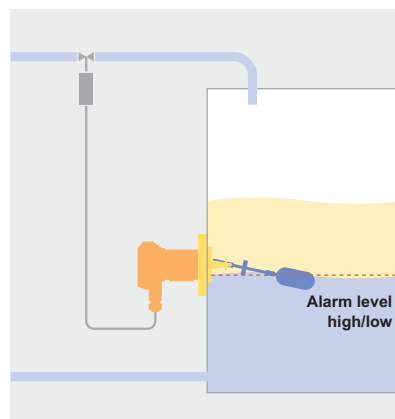

External fill level monitoring

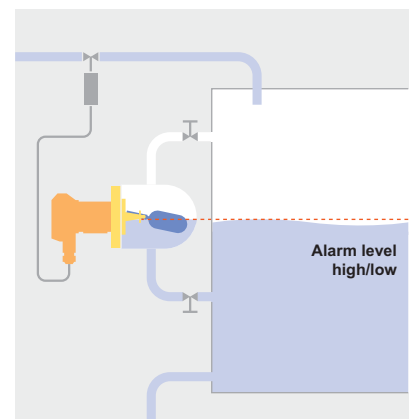

Reliable, user-friendly and easy to integrate at any time



Trimod Besta level switches feature a unique robustness. They are easily handled and quickly connected. Of course, the lid and screws can never be lost.

SIL
IEC 61508/61511 SIL 3 Capable

QUALITY - RIGHT DOWN TO THE DETAILS

- 01 Wiring diagram on inside of cover
- 02 Self-lifting, easily accessible ground terminal
- 03 Self-lifting terminals
- 04 The switch module can be disassembled with just two screws.
- 05 IP65: captive moulded seal. IP67 and IP68: O-ring seal.
- 06 Easily accessible equipotential bonding
- 07 Captive cover screws
- 08 Captive cover
- 09 Housing made of seawater resistant die cast aluminium, chromated aluminium or stainless steel (CrNiMo)
- 10 Simple cable routing, due to plenty of space and large cable radii allowed
- 11 Cable gland supplied (excluding explosion proof versions)
- 12 Electrical, electronic and pneumatic output signals
- 13 Double snap effect through magnetic repulsion and microswitch snap action
- 14 Mechanically rigid separation between medium and ambience

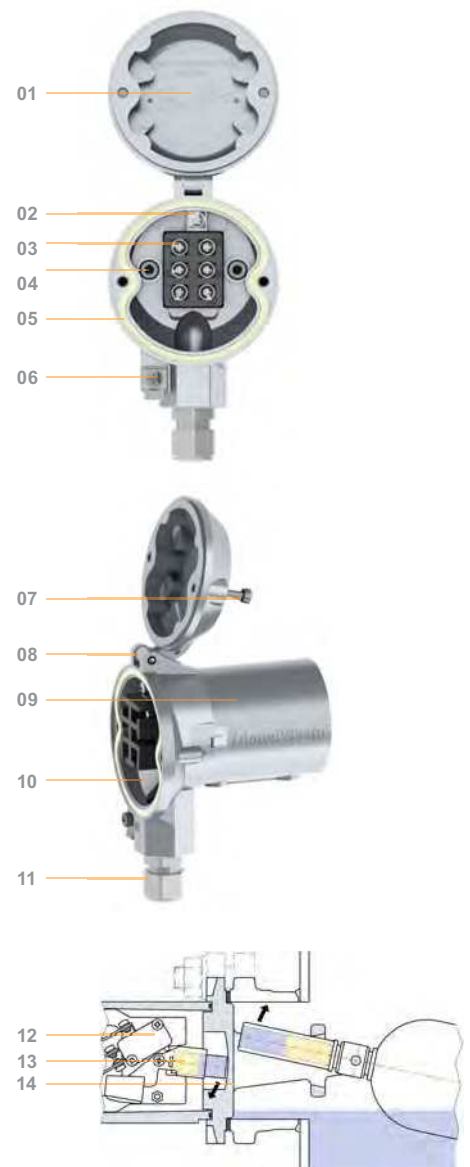

Made possible by the 3 - modular concept: unlimited variety of switches

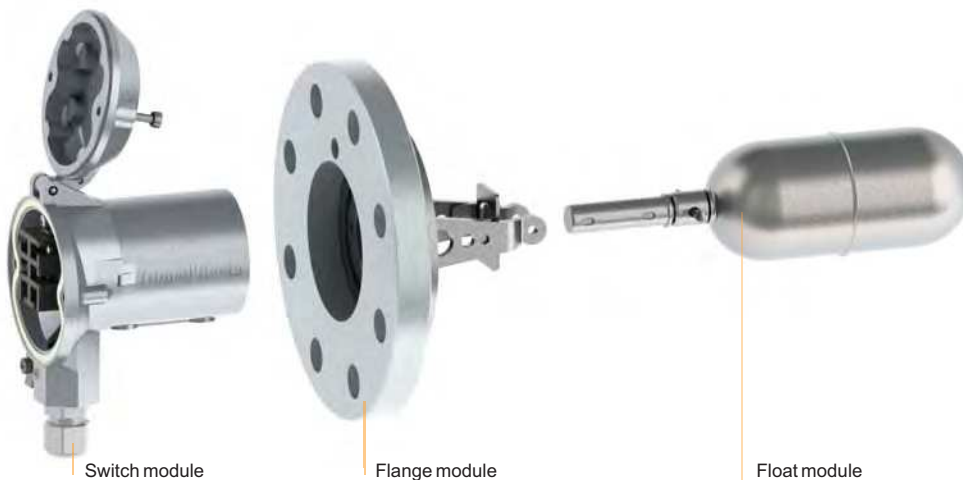

SWITCH MODULES

- switching elements: micro- and proximity switches
- SPDT and 2xSPDT
- pneumatic with ON/OFF output; max. 10 bar
- pneumatic with proportional output; 0.2 to 1 bar
- housings made of aluminium and CrNiMo
- high and low temperature versions; -200 to +400°C
- IP65 to IP68 protection
- explosion proof versions; ATEX, IECEx
- self lifting terminals for perfect connections
- Safety Integrity Level (SIL): SIL 1 and SIL 2

FLANGE MODULES

- stainless steel (CrNiMo) 1.4408 square flange, 92 mm pitch circle diameter
- DIN, ANSI, BS and JIS compliant industrial flanges
- special flanges with 98, 105 and 114 mm pitch circle diameters
- fixed flanges made of CrNiMo
- composite flanges made of H II (carbon steel) and CrNiMo
- special flanges made of Hastelloy
- DN 65 to 150, 3" to 6"
- PN 16 to 315, class 150 to 2500, table E to T, 5K to 63K
- flat seal, tongue and groove, ring joint etc.

FLOAT MODULES

- fixed operating differential 12 mm
- adjustable operating differential for pump control, vertical max. 2840 mm, horizontal max. 557 mm
- stainless steel (CrNiMo) and Hastelloy floats
- NACE compliant floats
- plastic floats made of PP, PVDF and PTFE
- stainless steel (CrNiMo) versions up to a maximum operating pressure of 350 bar
- float modules for separation layer monitoring
- stainless steel (CrNiMo) floats with polyamide and halar coating

Customer-specific solutions based on cost-effective standard components

SIDE MOUNT COMBINATIONS

- 01 with microswitch or proximity switches, also available in ATEX- and IECEx-compliant explosion proof versions
- 02 pneumatic switch module with ON/OFF or proportional output
- 03 with enclosure IP68 for underwater installation
- 04 ATEX-compliant for explosion proof applications in a pressure-capsulated housing with microswitch or initiator
- 05 with heat exchanger for very high or very low operating temperatures
- 06 square standard flanges made of CrNiMo, 92 mm pitch circle diameter
- 07 industrial flange acc. to DIN, ANSI, BS and JIS made of PP and PTFE
- 08 industrial flange acc. to DIN, ANSI, BS and JIS made of CrNiMo and Hastelloy
- 09 with fixed operating differential
- 10 with rod extension for longer operating differentials
- 11 rod extension for switch point correction
- 12 with protective bellows for media with solids content
- 13 with adjustable operating differential for pump control
- 14 plastic versions for aggressive media
- 15 for separation layer monitoring of two media with different densities
- 16 for vertical mounting
- 17 for vertical mounting in plastics
- 18 for vertical mounting with rod extension

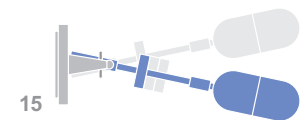
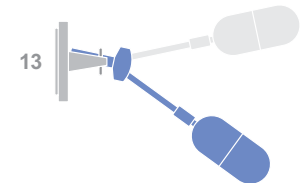
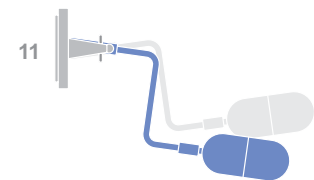
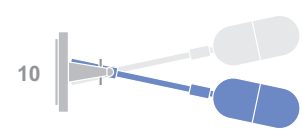
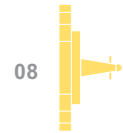
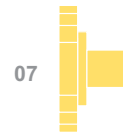
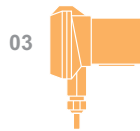
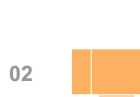
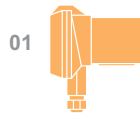

TOP MOUNT COMBINATIONS

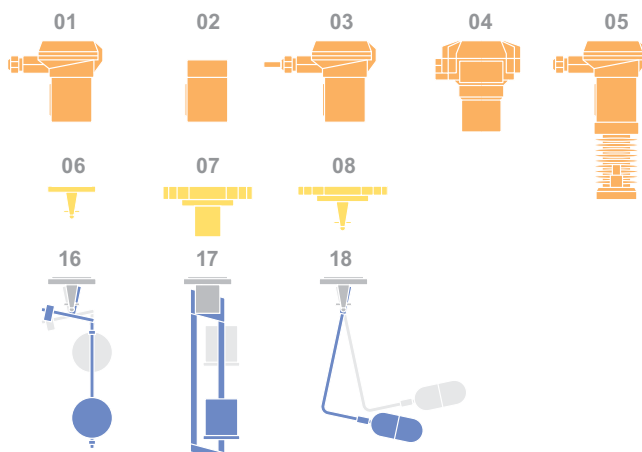

The Trimod Besta standard range: versatile, robust and economical



Trimod Besta, the flexible solution. It can be used anywhere, no matter where and when. Its versatility is unlimited, for high temperature, freezing cold, low density, vacuum or high pressure applications.

THE MOST POPULAR SWITCHES

Type A 01 041 alarm, limit and control functions

Nominal pressure	PN 25 acc. to DIN
Operating temperature	0 to 300°C
Ambient temperature	0 to 70°C
Density of the liquid	0.7 kg/dm ³
Operating differential	fixed 12 mm
Wetside material	stainless steel (CrNiMo)
Switch module material	seawater resistant die cast aluminium
Flange dimensions	square 92 x 92 mm, PCD 92 mm
Switch element	microswitch SPDT with silver contacts
Switch rating	250 VAC, 5A 30 VDC, 5A
Enclosure	IP65
Installation depth (tank)	226 mm
Safety Integrity Level (SIL)	SIL 1 (Type AA 01 041: SIL 2)

SIMILAR TYPES

Type A 01 04 same as A 01 041, in addition, rod extensions G1, G2 and G3 can be used.

Type 5A 01 041 for aggressive environments, housing exclusively made of stainless steel (CrNiMo).

Type 2A 01 041 with chromated switch housing

Type A 01 07 for low densities: 0.5 kg/dm³

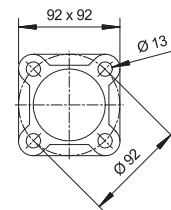
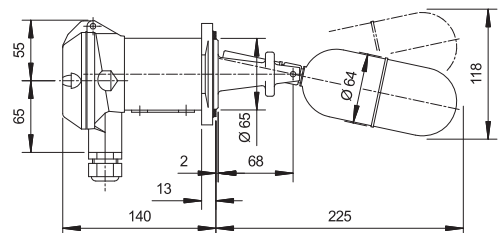

Type A 01 051 to A 01 054 with protective bellows for dirty media

Type A 01 051

Bellow material Perbunan
 Operating temperature 0 to 120°C
 Safety Integrity Level (SIL) SIL 1 (Type AA 01 051: SIL2)

Type A 01 052

Bellow material Silicone
 Operating temperature 0 to 200°C
 Safety Integrity Level (SIL) SIL 1 (Type AA 01 052: SIL2)

Type A 01 053

Bellow material FPM
 Operating temperature 10 to 200°C
 Safety Integrity Level (SIL) SIL 1 (Type AA 01 053: SIL2)

Type A 01 054

Bellow material PTFE
 Operating temperature 0 to 250°C
 Safety Integrity Level (SIL) SIL 1 (Type AA 01 054: SIL2)

Installation length 253 mm
 Other technical data same as A 01 041

SIMILAR TYPE

Type A 01 051E15 special version for waste water and waste tanks. Technical data similar to A 01 051

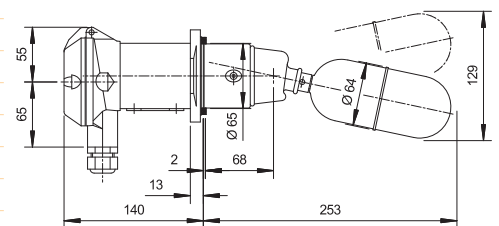

FOR MANUALLY ADJUSTABLE OPERATING DIFFERENTIALS

Type A 01 090 to A 01 093 ideal for 2-point control, e.g. for pump control

Type A 01 090

Adjustable operating differential 37 to 218 mm

Type A 01 091

Adjustable operating differential 56 to 317 mm

Type A 01 092

Adjustable operating differential 83 to 442 mm

Type A 01 093

Adjustable operating differential 97 to 557 mm

Installation length 278 to 561 mm, depending on type
 Density of the liquid min. 0.75 kg/dm³
 Safety Integrity Level (SIL) SIL 1 (Types AA 01 090 to AA 01 093: SIL 2)
 Other technical data same as A 01 041

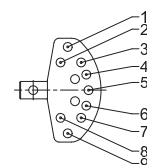
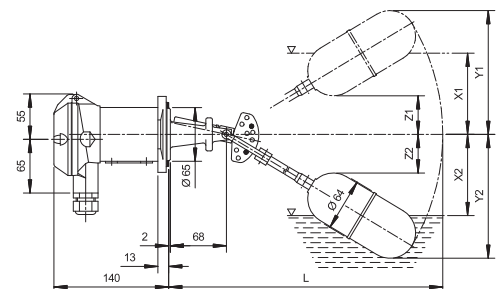

PNEUMATIC SWITCH

Type P 01 04 the pneumatic limit switch

Function	ON/OFF (3/2 way valve)
Max. control pressure	max. 10 bar
Nominal pressure	PN 25 acc. to DIN
Operating temperature	1 to 250°C
Ambient temperature	1 to 80°C
Density of the liquid	min. 0.7 kg/dm ³
Operating differential	fixed 12 mm
Control connections	G 1/8" (BSPP) inside thread
Wetside material	stainless steel (CrNiMo)
Housing material	seawater resistant die cast aluminium

Options

Type 5P 01 04 all stainless steel (CrNiMo) design
Type FP 01 04 with declaration of conformity for use in
 Explosion proof areas

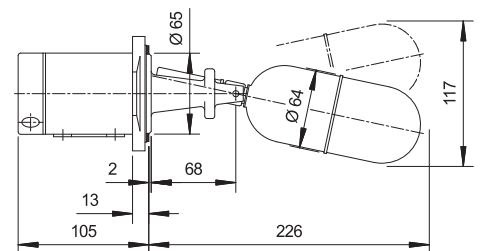
**PNEUMATIC CONTROLLER**

Type M 01 04 the pneumatic controller

Function	proportional controller
Supply pressure	1.4 bar
Output signal	0.2 to 1 bar
Nominal pressure	PN 25 acc. to DIN
Operating temperature	1 to 250°C
Ambient temperature	1 to 80°C
Density of the liquid	min. 0.7 kg/dm ³
Control range	without rod: 30 mm with rod: max. 230 mm
Control connections	G 1/8" (BSPP) inside thread
Wetside material	stainless steel (CrNiMo)
Housing material	seawater resistant die cast aluminium

Options

Type 5M 01 04 all stainless steel (CrNiMo) design
Type FM 01 04 with declaration of conformity for use in
 Explosion proof areas

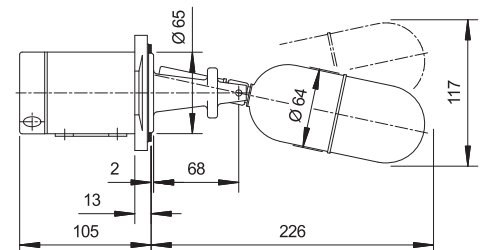

VERTICAL SWITCH

Type A 01 140 and A 01 141	for top mount installations
Function	2-point control (pump) or 1 switching point (alarm)
Nominal pressure	PN 16 acc. to DIN
Operating temperature	0 to 300°C
Ambient temperature	0 to 70°C
Density of the liquid	Pump control: min. 0.45 kg/dm ³ Alarm: min. 0.30 kg/dm ³
Operating differential	A 01 140: 12 to 1340 mm A 01 141: 12 to 2840 mm
Wetside material	stainless steel (CrNiMo)
Housing material	seawater resistant die cast aluminium
Flange dimensions	square 92 x 92 mm, PCD 92 mm
Switch element	microswitch SPDT with silver contacts
Switch rating	250 VAC, 5A 30 VDC, 5A
Enclosure	IP65
Safety Integrity Level (SIL)	SIL 1 (Types AA 01 140 and AA 01 141: SIL 2)

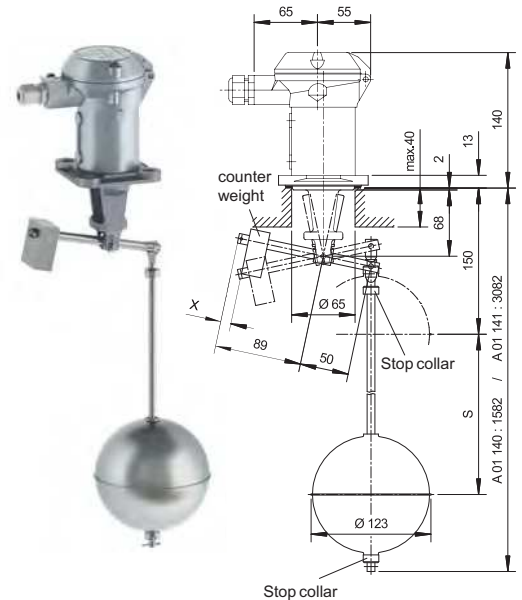
**COUNTERFLANGE** - for convenient mounting of float switches**Counterflange V = 38 mm**

Type 2829.1*	Flange: C22.8	Stud: 5.8
Type 2829.2	Flange: C22.8	Stud: 5.8
Type 2831.3*	Flange: 1.4404	Stud: A2
Type 2831.4	Flange: 1.4404	Stud: A2

Counterflange V = 80 mm

Type 2829.1V80*	Flange: C22.8	Stud: 5.8
Type 2829.2V80	Flange: C22.8	Stud: 5.8
Type 2831.3V80*	Flange: 1.4404	Stud: A2
Type 2831.4V80	Flange: 1.4404	Stud: A2

* not for use with the test actuator

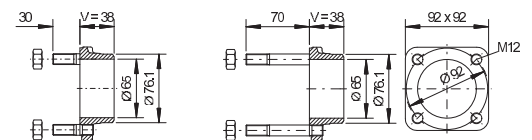

Type 2829.1 & 2831.3

Type 2829.2 & 2831.4

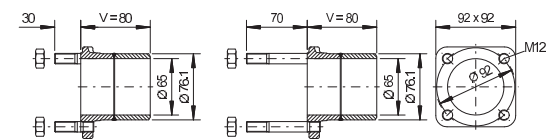

Type 2829.1V80 & 2831.3V80 Type 2829.2V80 & 2831.4V80

TEST ACTUATOR

The test actuator allows a periodic manual function check of the level switch in operating status. The following functions can be tested; function of the switching element (microswitch, proximity switch, pneumatic valve) and movement of the float.

Important: Not for use with the Compact Switch.

Type 2382	Material: CrNi	O-Ring: FPM
Type 2383	Material: CrNi	O-Ring: EPDM

**COUNTERFLANGE WITH TEST ACTUATOR, V = 50mm**

Type 2865	Flange: C22.8	O-Ring: FPM
Type 2866	Flange: C22.8	O-Ring: EPDM
Type 2868	Flange: 1.4404	O-Ring: FPM
Type 2869	Flange: 1.4404	O-Ring: EPDM

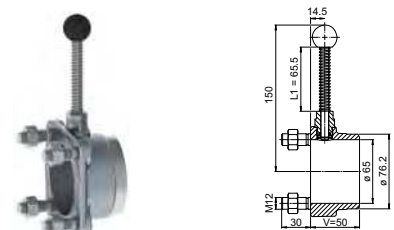

The Trimod Besta industrial range for challenging applications



The benefits of the wide spectrum of Trimod Besta switches are especially obvious in the industrial range. They are the best choice for high operating pressures, aggressive media and high process temperatures up to 400°C.

SIL
IEC 61508/61511 SIL 3 Capable

A TYPICAL TRIMOD BESTA INDUSTRIAL SWITCH

Type A 22C 04	for alarm, limit and control functions
Nominal pressure	PN 40 acc. to DIN
Operating temperature	0 to 330°C
Ambient temperature	0 to 70°C
Density of the liquid	min. 0.7 kg/dm ³
Operating differential	fixed 12 mm
Wetside material	stainless steel (CrNiMo)
Slip-on flange	carbon steel H II zinc galvanized and passivated
Housing material	seawater resistant die cast aluminium
Flange	DN 65, PN 40 acc. to DIN 2501
Flange facing	smooth raised face, form C, DIN 2526
Switch element	microswitch SPDT with silver contacts
Switch rating	250 VAC, 5A 30 VDC, 5A
Enclosure	IP65
Weight	5.4 kg
Installation depth (tank)	226 mm
Safety Integrity Level (SIL)	SIL 1 (Type AA 22C 04: SIL 2)

Flanges acc. to DIN 2501	DN 65 to DN 150 PN 16 to PN 315
Flanges acc. to ANSI B16.5	DN 3" to DN 6" PN cl. 150 to PN cl. 2500
Flanges acc. to BS 10	DN 3" to DN 6" PN Table E to PN Table T
Flanges acc. to JIS B 2220	DN 65 to DN 125 PN 5K to PN 63K

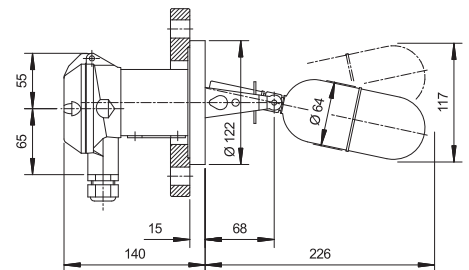

The Trimod Besta plastic range for highly aggressive media



All wetted parts are made of high grade plastics such as PP, PTFE or PVDF. The switches are available with DIN, ANSI, BS and JIS industrial flanges.

A TYPICAL TRIMOD BESTA PLASTIC SWITCH

Type A 304 98 PTFE switch, alarm, limit and control functions

Nominal pressure	PN 10 acc. to DIN
Operating temperature	0 to 200°C
Ambient temperature	0 to 70°C
Density of the liquid	min. 0.75 kg/dm ³
Operating differential	fixed 12 mm
Wetside material	PTFE with 25% glass fibre
Slip-on flange	carbon steel H II zinc galvanized and passivated
Housing material	seawater resistant die cast aluminium
Flange	DN 80, PN 10 acc. to DIN 2501
Flange facing	smooth raised face, form C, DIN 2526
Switch element	microswitch SPDT with silver contacts
Switch rating	250 VAC, 5A 30 VDC, 5A
Enclosure	IP65
Weight	5 kg
Installation depth (tank)	235 mm

Flanges acc. to DIN 2501 PN 10, DN 80 to DN 150

Flanges acc. to ANSI B16.5 PN cl. 150, DN 3" to DN 6"

Flanges acc. to BS 10 PN Table E, DN 3" to DN 6"

Flanges acc. to JIS B 2220 PN 10K, DN 80 to DN 150

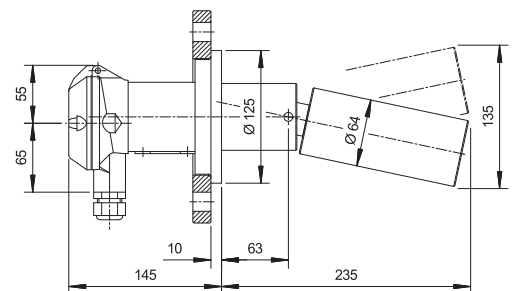

Hundreds of thousands of Trimod Besta switches ensure the safe voyage of vessels on our oceans



Since 1967 Trimod Besta limit switches are a huge success in the ship building industry. They are installed in tankers, cruise ships, container ships and submarines - and even on the fastest catamaran and the strongest crane ship in the world.

THE FAVOURITES

Type A 01 041	the allrounder
Nominal pressure	PN 25 acc. to DIN
Operating temperature	0 to 300°C
Ambient temperature	0 to 70°C
Density of the liquid	0.7 kg/dm ³
Operating differential	fixed 12 mm
Wetside material	stainless steel (CrNiMo)
Housing material	seawater resistant die cast aluminium
Flange dimensions	square 92 x 92 mm, PCD 92 mm
Switch element	microswitch SPDT with silver contacts
Switch rating	250 VAC, 5A 30 VDC, 5A
Enclosure	IP65
Installation depth (tank)	226 mm
Safety Integrity Level (SIL)	SIL 1 (Type AA 01 041: SIL 2)

Type U3A 01 041	underwater version IP68
Nominal pressure	PN 25 acc. to DIN
Operating temperature	-30 to 80°C
Ambient temperature	-30 to 80°C
Enclosure	IP68, switch housing pressure tight up to 100 meters water column
Cable length	3 m, or as required
Cable type	Neoprene (H07 RN-F)
Safety Integrity Level (SIL)	SIL 1 (Type U3AA 01 041: SIL 2)
Other technical data	same as A 01 041

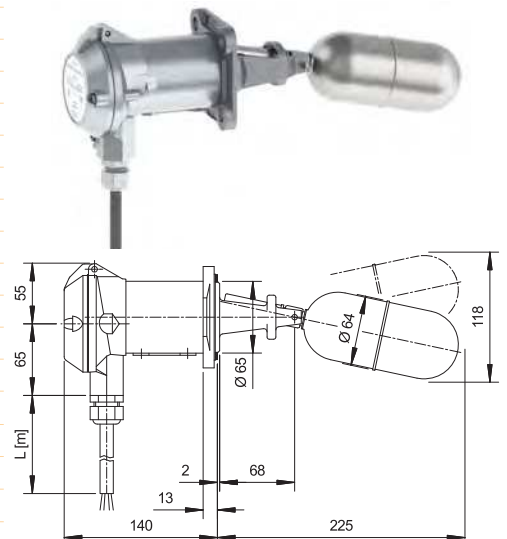
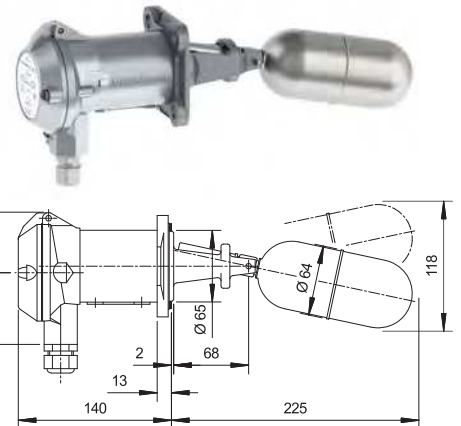

Marine approvals and registrations of Trimod Besta limit switches



Trimod Besta level switches come with the required shipping approvals and registrations. See our homepage for up to date listings.

APPROVALS

- American Bureau of Shipping, ABS
- Bureau Veritas, BV
- Det Norske Veritas, DNV
- Germanischer Lloyd, GL
- Lloyd's Register of Shipping, LRS
- Registro Italiano Navale, RINA
- Russian Maritime Register of Shipping, RMRS
- China Classification Society, CCS



Cat Link V, the 91 meter long catamaran of the Incat Ship Yard in Australia. Its transatlantic crossing at an average speed of 41.28 knots set a new record.

Trimod Besta level switches AA 01 04 and AA 01 093 are used to monitor and control levels on board.

Trimod Besta, whenever reliability is crucial



Thanks to high functional safety and extreme longevity, Trimod Besta level switches are proven in petrochemical plants and on offshore platforms.

The switches are available with DIN, ANSI, BS and JIS flanges.



A TYPICAL INDUSTRIAL SWITCH FOR USE IN EXPLOSION PROOF AREAS

Type ZK8 22C 041 hermetically sealed for alarm, limit and control functions

Type of protection	EEx ed IIC T6
EU approval	PTB 03 ATEX 1006
Nominal pressure	PN 40 acc. to DIN
Operating temperature	-10 to 145°C
Ambient temperature	acc. to EN 50014
Density of the liquid	min. 0.7 kg/dm ³
Operating differential	fixed 12 mm
Wetside material	stainless steel (CrNiMo)
Slip-on flange	carbon steel (H II), zinc galvanised and passivated
Housing material	seawater resistant die cast aluminium
Flange	DN 65, PN 40 acc. to DIN 2501
Flange facing	raised face type C, DIN 2626
Switch element	microswitch SPDT with silver contacts
Switch rating	250 VAC, 5A 30 VDC, 5A
Safety Integrity Level (SIL)	SIL 1 (Type ZKK8 22C 041: SIL 2)
Enclosure	IP67

Type XA8 22C 041 pressure capsulated for alarm, limit and control functions

Type of protection	Ex de IIC T6
EU approval	EPS 09 ATEX 1238 X
Operating temperature	-10 to 330°C
Housing material	seawater resistant die cast aluminium
Safety Integrity Level (SIL)	SIL 1 (Type XAA8 22C 041: SIL 2)
Other technical data	same as ZK8 22C 041

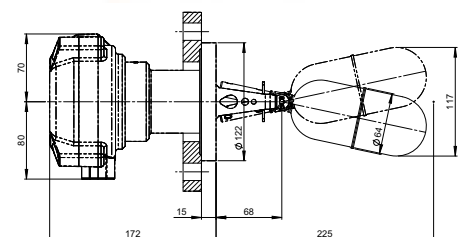
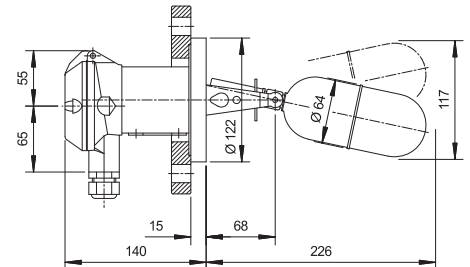

Trimod Besta limit switches in customized float chambers



Besta has many years of experience concerning the use of level switches in float chambers and containers. We offer the following approvals and services:

- Manufacturer approvals
- Procedure Qualification Record
- Welding certificates
- PED conformity

WE DELIVER ACCURATE, TESTED AND PRE INSTALLED.

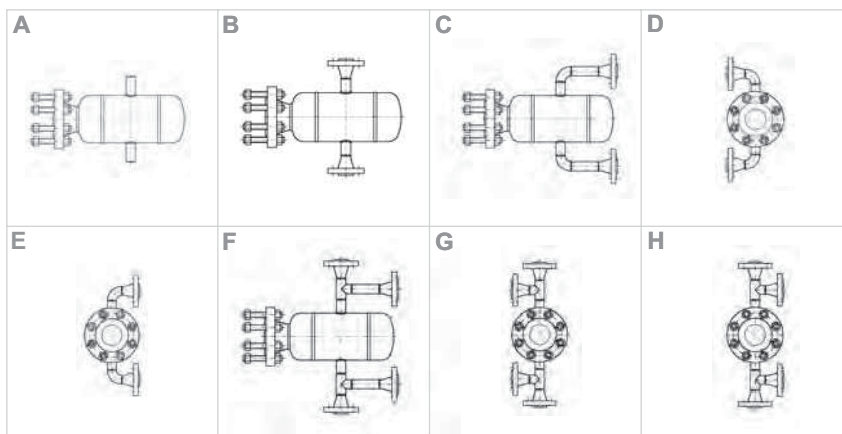

DOCUMENTATION AND SERVICES

- Works certificates acc. to EN 10204-2.2
- Test certificates acc. to EN 10204-3.1
- Pressure test protocols
- Detailed documentation: parts information with technical specifications and material data, including lot and charge information
- Non-destructive testing: ultrasonic, x-ray and dye penetration testing
- Mechanical testing: tension, notch and hardness tests
- Base- and protective coatings

BESTA

Besta AG
Ackerstrasse 45
CH-8610 Uster, Switzerland
Phone +41 43 399 15 15
Fax +41 43 399 15 00
info@besta.ch
www.besta.ch

Quality Management

The Besta Ltd. quality management system acc. to ISO 9001 has been established in 1991.

Registered Trade Marks

Trimod and Besta are registered trademarks of Besta Ltd., Switzerland.

Homepage

Find your local sales and service partner under
www.besta.ch.

Please find more detailed information in our Trimod Besta catalogue.
Download under www.besta.ch

Our markets



Shipbuilding



Oil & Gas



Chemical & Petrochemical



Power Generation



Plant engineering



Water management